

MOTOR SPECIFICATION SHEET

MODEL : SF-JRV 10HP 2P (LT)

USED FOR : STANDARD

DESCRIPTION	DETAIL				
PHASE	3				
MODEL NAME	SF-JRV				
RATED OUTPUT, HP (kW)	10 (7.5)				
POLE	2				
CODE	MEATH CODE : 1M002V-200750LFFY0				
OUTLINE DRAWING NO.	OMM24O158-B				
RATED VOLTAGE (V)	220	380	415	220	440
RATED FREQUENCY (Hz)	50	50	50	60	60
RATED CURRENT (A)	25.0	14.5	14.1	24.5	12.4
RATED SPEED (min ⁻¹)	2910	2910	2920	3490	3510
THERMAL CLASS	155(F)				
RATING	S1 (CONTINUOUS)				
ENCLOSURE CONSTRUCTION	TOTALLY ENCLOSED FAN COOLED				
DEGREES OF PROTECTION	IP55				
METHOD OF COOLING	IC411				
FRAME NO.	132S				
WEIGHT (kg)	63				
STANDARD	IEC 60034-1, JEC-2137-2000				
INSTALLATION	FLANGE MOUNTED (VERTICAL)				
ROTATION	CCW (VIEWED FROM SHAFT END)				
BEARING	LOAD SIDE : 6308ZZ OPPOSITE SIDE : 6207ZZ				
BEARING GREASE	UREA GREASE				
NOISE (db.A)	84				
VIBRATION	V10				
CIRCUMSTANCE CONDITION	AMBIENT TEMPERATURE : -20 ~ +40°C AMBIENT HUMIDITY : 95%RH OR LESS ABOVE SEA LEVEL : 1000m OR LESS ENVIRONMENT : NO BURSTING/EROSIVE GAS OR VAPOR				
COLOR	MUNSELL N5.5 (GRAY)				
TERMINAL BOX	NO. OF LEAD WIRES : 6 SOURCE CONNECTION : TERMINAL BLOCK				
INSULATION RESISTANCE	BY DC 500V MEGGER - ≥100MΩ				
DIELECTRIC TEST	AC 50Hz 1800V - 1min. (Based on rated voltage 380V)				
SHAFT SWING	≤0.03mm				
MATERIAL	FRAME : STEEL PLATE BRACKET LOAD SIDE : CAST IRON (FLANGE) OPPOSITE SIDE : ALUMINIUM SHAFT : CARBON STEEL STATOR CORE : ELECTRICAL STEEL WIRE : ENAMELLED COPPER MAGNET WIRE INSULATOR : POLYESTER FILM SATURATED WITH RESIN VARNISH : EPOXY DENATURALIZATION POLYESTER ROTOR CORE : ELECTRICAL STEEL CONDUCTOR : ALUMINIUM TERMINAL BOX : STEEL PLATE PAINTING : POLYURETHANE RESIN				
PRODUCTION COUNTRY	THAILAND				

Specifications subject to change without notice.

SPECIFICATION SHEET NO.

SS-M-2268-A

MODEL SF-JRV THREE PHASE INDUCTION MOTOR OUTLINE DRAWING

TOTALLY ENCLOSED FAN COOLED
 DEGREES OF PROTECTION IP55
 DUST & WATER JET PROOF

CUSTOMER _____
 USER _____
 FOR _____
 CUSTOMER'S ORDER NO. _____
 QUANTITY _____
 MFG. ORDER NO. _____

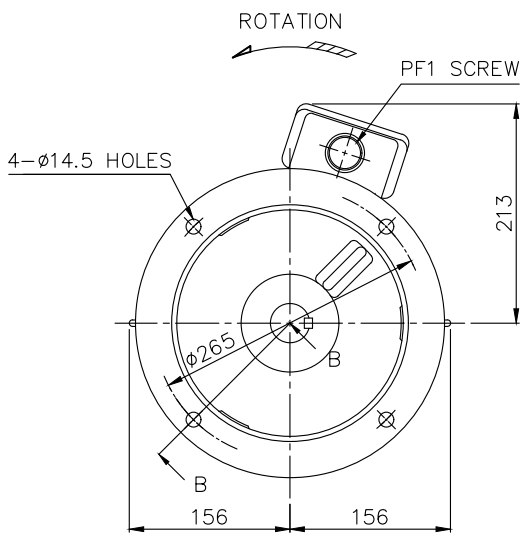
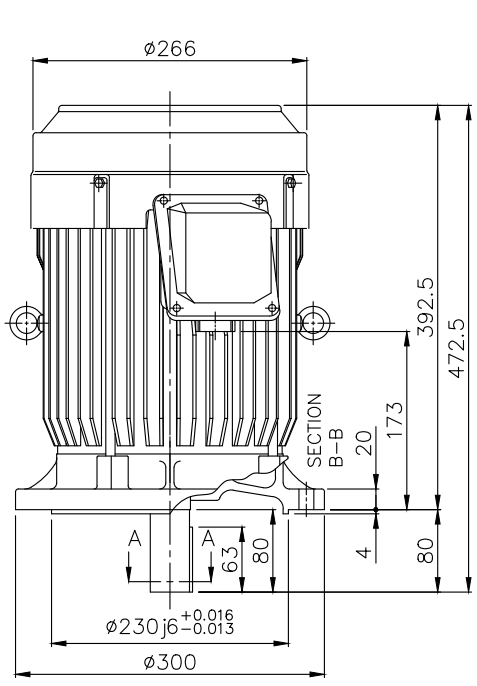

BOTTOM VIEW OF SHAFT END

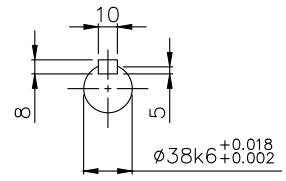

SECTION A-A

YOUR ORDER	FRAME SIZE	RATING	TH. CLASS	AMB. TEMP.	BEARINGS		COLOR	DIRECTION OF ROTATION (VIEWED FROM SHAFT END)	NO. OF LEAD WIRES	REMARKS
					LOAD SIDE	OPP. SIDE				
	132S	S1 (CONT.)	155(F)	40°C	6308ZZ	6207ZZ	GRAY (MUNSELL N5.5)	CCW	6	

YOUR ORDER	OUTPUT		POLES	VOLT	HERTZ	REMARKS
	HP	kW				
	7.5	5.5	2	220/380/415	50	LT
				220/440	60	
	10	7.5	2	220/380/415	50	LT
				220/440	60	
	7.5	5.5	4	220/380/415	50	LT
				220/440	60	
	5	3.7	6	220/380/415	50	LT
				220/440	60	
	7.5	5.5	2	380/415	50	HT
				380/440	60	
	10	7.5	2	380/415	50	HT
				380/440	60	
	7.5	5.5	4	380/415	50	HT
				380/440	60	
	5	3.7	6	380/415	50	HT
				380/440	60	

MITSUBISHI ELECTRIC AUTOMATION (THAILAND) CO., LTD.

		OUTLINE DRAWING NO.	REV.
	DIMENSION IN mm.	O M M 2 4 0 1 5 8	B
SCALE : NTS			